

**TERMINALE
HEM BAR
BARRE FINALE**

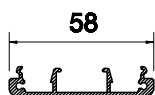

**LAMELLA
SLAT
LAMELLE**

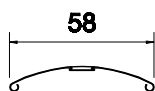

**CASSONETTO
HEAD BOX
CAISSON**

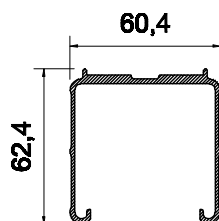

**SUPPORTO CASSONETTO
HEAD BOX SUPPORT
SUPPORT CAISSON**

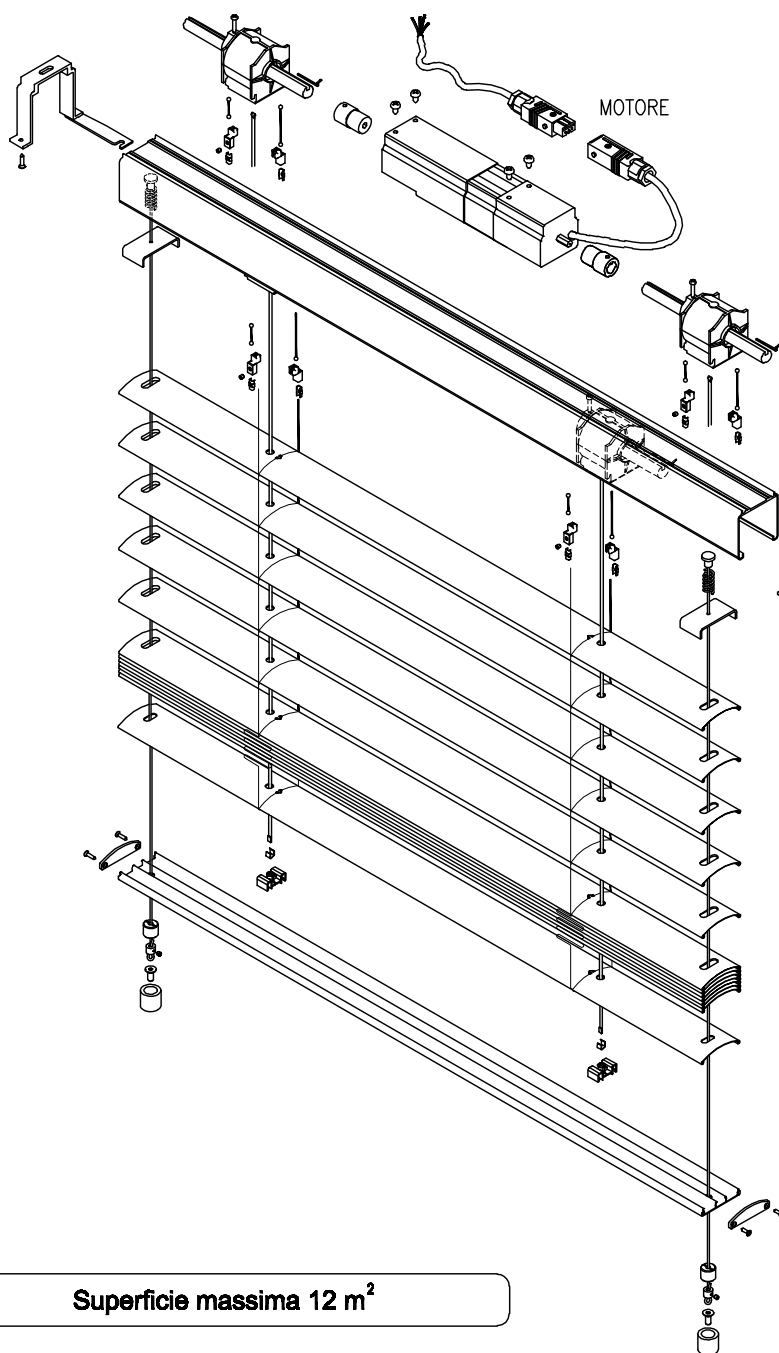
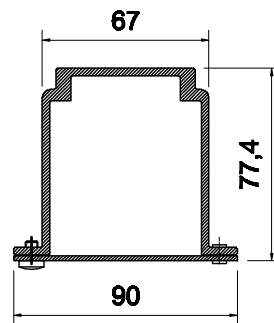

**CAVO INOX
STAINLESS STEEL CABLE
CABLE GUIDAGE**

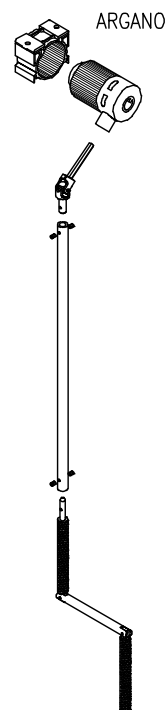
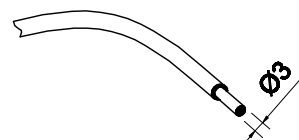

Superficie massima 12 m²

Dimensioni di Costruzione

Comando	L min	L max	H min	H max
MOTORE	600	3.600	700	4.800
ARGANO	600	2.500	700	3.500