

**TERMINALE  
HEM BAR  
BARRE FINALE**

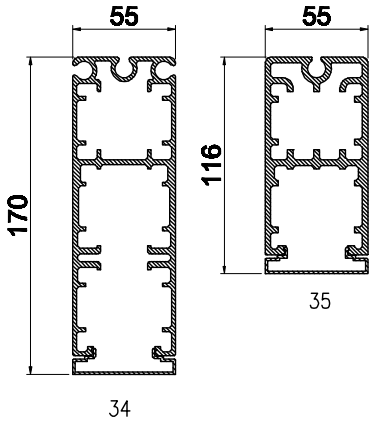

**GUIDA  
GUIDE  
COULISSE**

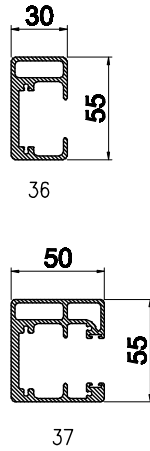

**CASSONETTO  
HEAD BOX  
CAISSON**

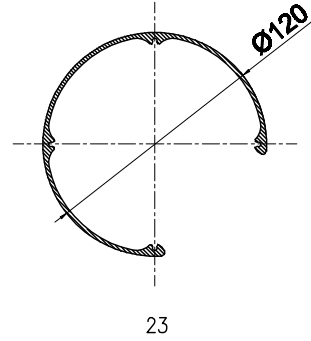

**TETTuccio - COVERING - TOITURE**

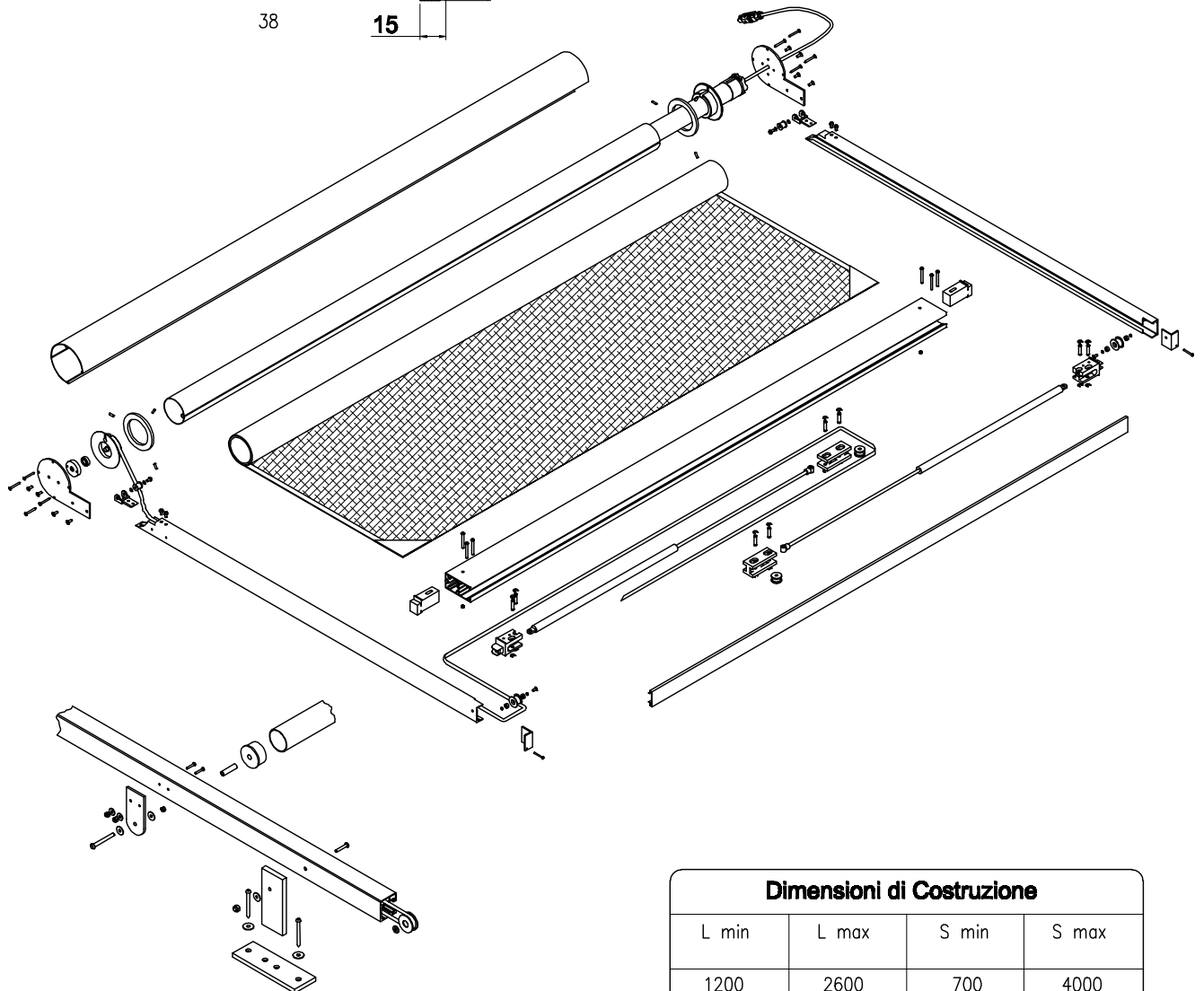
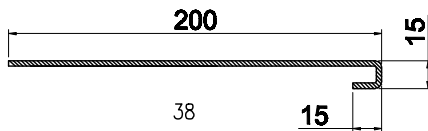

**Dimensioni di Costruzione**

L min	L max	S min	S max
1200	2600	700	4000